

NECTOR M SEALED PCB PANEL MOUNT

TE Connectivity's (TE) NECTOR M power system is a flexible, fully pluggable, modular wiring connector and cabling solution for the permanent & temporary power and control of electrical installations. NECTOR M power system offers an ideal solution for both indoor and outdoor high humidity installations, also enabling a reconfigurable, easy-to install and time saving alternative to the traditional hard-wired electrical connections. The newly added IP67 PCB Panel Mount part allows the connectivity to internal electronics without the need to solder individual wires.



Applications

- Street and Area Lighting
- Outdoor Luminaires
 - Wall Packs
 - Parking Lots
 - Walkways
- Photo Controls
- Central Management System
- Other sensor modules e.g. occupancy

Electrical

- Operating Voltage: 400 VAC IEC rating
600 VAC UL rating

Mechanical

- Operating Temperature: -40°C to 85°C
- IP Seal Rating: IP67
- UV Resistant: Yes
- Termination Type: PCB Mount

Product Specifications

- Product Specification: [108-133014](#)
- Application Specification: [114-32111](#)

Materials

- Housing Material: Glass Filled PBT

Benefits

- IP67 protected solution for PCB to panel
- 7 pole solution with very small diameter 25mm
- Improved installation efficiency with one connector solution that addresses power, data and control requirements
- Enables design consistency with the same size knock out diameter for a multi-position 5, 6 and 7 pole connector system
- Reduces installation time, on-site labor cost and waste with a multi-functional modular system
- Supports easy field installation (with NECTOR M Sealed Power System) and simplifies routing during installation with a circular form factor that requires less real estate

Product Selection Information

| | Part Number | Description |
|---|---------------------------|--|
|  | 2307526-1 | NECTOR M 7P Sealed Socket PCB Code A |
|  | 2307526-2 | NECTOR M 7P Sealed Socket PCB Code B |
|  | 2312169-1 | NECTOR M Sealed PCB O Ring |
|  | 2213430-1 | NECTOR M 5/6/7P Screw Nut, Panel Mount |

7 Pole PCB Mounted Sealed Socket Header

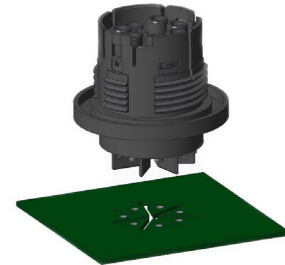

Dimensions

Part Number 2307526-1

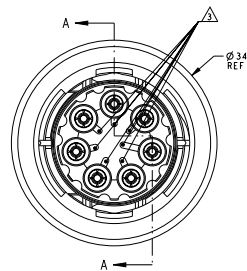
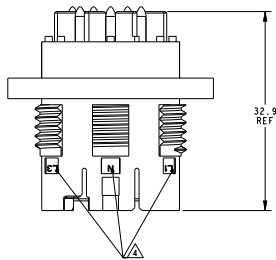

Part Number 2312169-1

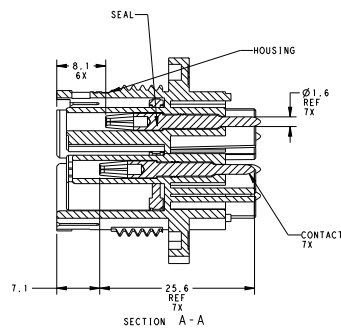
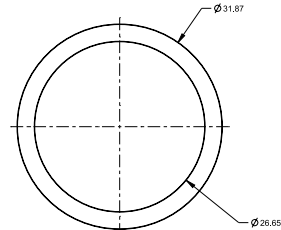

Panel Mount Application

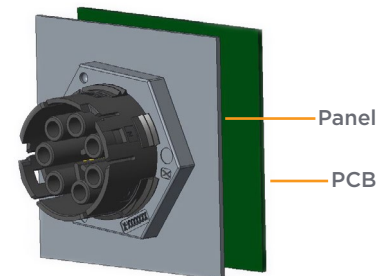
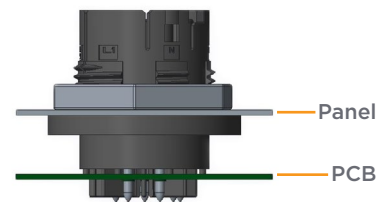

te.com

© 2017 TE Connectivity. All Rights Reserved. NECTOR, TE, TE Connectivity, and the TE connectivity (logo) are trademarks of the TE Connectivity Ltd. family of companies. Other logos, product and Company names mentioned herein may be trademarks of their respective owners.

While TE has made every reasonable effort to ensure the accuracy of the information in this brochure, TE does not guarantee that it is error-free, nor does TE make any other representation, warranty or guarantee that the information is accurate, correct, reliable or current. TE reserves the right to make any adjustments to the information contained herein at any time without notice. TE expressly disclaims all implied warranties regarding the information contained herein, including, but not limited to, any implied warranties of merchantability or fitness for a particular purpose. The dimensions in this catalog are for reference purposes only and are subject to change without notice. Specifications are subject to change without notice. Consult TE for the latest dimensions and design specifications.

1-1773923-3 JN 05/2017

USA: +1 (800) 522-6752
 Canada: +1 (905) 475-6222
 Mexico: +52 (0) 55-1106-0800
 Latin/S. America: +54 (0) 11-4733-2200
 Germany: +49 (0) 6251-133-1999
 UK: +44 (0) 800-267666
 France: +33 (0) 1-3420-8686
 The Netherlands: +31 (0) 73-6246-999
 China: +86 (0) 400-820-6015