



BOARD LEVEL COOLING - 3744

3744 is a series of square pin fin board level heat sinks designed to cool BGA and FPGA devices. Representative Image Only.

ORDERING INFORMATION

Part Number	Device Type
374424B00035G	BGA, FPGA
374424B60023G	BGA, FPGA

HEAT SINK DETAILS

Property	Details
Material	Aluminum
Finish	Black Anodize
Device Attachment Options: 374424B00035G	Tape
Device Attachment Options: 374424B60023G	Solder Anchor Clip
Thermal Interface Material: 374424B00035G	T411 Chomerics Tape for All Surfaces
Thermal Interface Material: 374424B60023G	T766 Chomerics Phase Change for All Surfaces

Property	Details
Heat Sink Width (mm)	27.00
Heat Sink Length (mm)	27.00
Heat Sink Height (mm)	18.00
Heat Sink Mounting Direction	Horizontal, Vertical

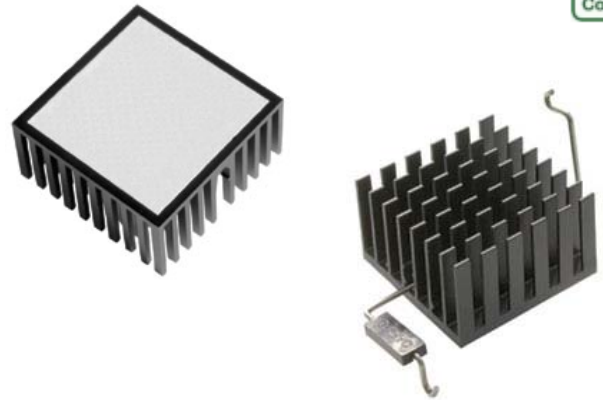

MECHANICAL & PERFORMANCE

Drawing dimensions are shown in mm, (in)

Part Number: 374424B00035G

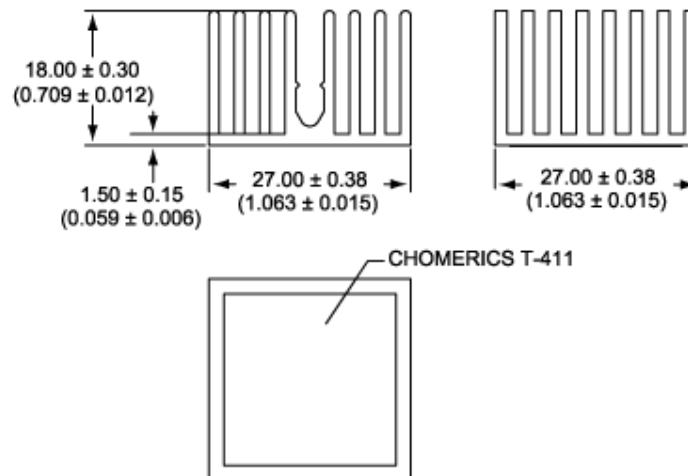

Part Number: 374424B60023G

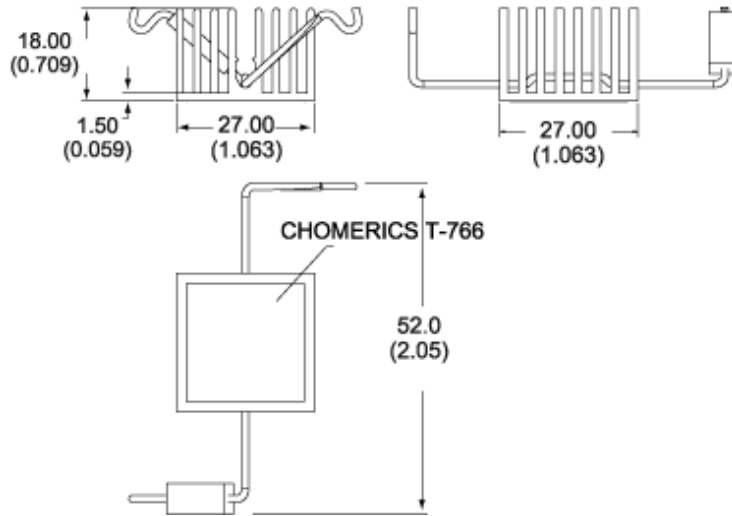

Mounting Details:

